

# Victron MultiPlus

Inverter/Charger Battery Back-Up - 500VA to 3000VA

Revision 4.0 - 02 April 2026



**IMPORTANT**

This Quick Guide should be read in conjunction with the Victron Installation Manual that is included in the box. If the manual is not included, please download it from the Victron website:

500VA & 1200 VA- [www.victronenergy.com/upload/documents/Manual-MultiPlus-500VA-1200VA-EN-NL-FR-DE-ES-IT.pdf](http://www.victronenergy.com/upload/documents/Manual-MultiPlus-500VA-1200VA-EN-NL-FR-DE-ES-IT.pdf)

2000VA - [https://www.victronenergy.com/media/pg/MultiPlus\\_2kVA\\_230V/en/index-en.html](https://www.victronenergy.com/media/pg/MultiPlus_2kVA_230V/en/index-en.html)

3000VA - [https://www.victronenergy.com/upload/documents/MultiPlus-II\\_230V/32424-MultiPlus-II\\_Quattro-II-pdf-en.pdf](https://www.victronenergy.com/upload/documents/MultiPlus-II_230V/32424-MultiPlus-II_Quattro-II-pdf-en.pdf)

Technical data, ancillary products and installation examples can be found in our [Technical Data Sheet](#).

The Victron Installation Manual includes the following, and should be read in full before this Quick Guide:

**1. SAFETY INSTRUCTIONS**

- General
- Installation
- Transport and Storage

**2. DESCRIPTION**

- General
- Battery Charger

**3. OPERATION**

- On / Off / Charger-only Switch
- Remote control
- LED Indications

**4. INSTALLATION**

- Location
- Connection of the Battery cables
- Connection of the AC cabling
- Optional Connections

**5. CONFIGURATION**

- Standard settings: ready for use
- Explanation of settings
- Configuration by computer
- Configuration with DIP switches

**6. MAINTENANCE**

**7. TROUBLESHOOTING TABLE**

**8. TECHNICAL DATA**

**INCLUDED WITHIN THE PACKAGING**

500VA & 800VA - The inverter and ancillaries are supplied in one box.

2000VA & 3000VA - The inverter and ancillaries are supplied in two boxes.

The battery(s) are supplied in separate packaging.

**DC CABLE SET 500VA & 800VA**

- 1 x Positive DC cable - Red - 0.8 m
- 1 x Positive DC cable - Red - 0.45 m
- 1 x Negative DC cable - Black - 1.2 m
- 1 x DC Isolator switch

**DC CABLE SET 2000VA & 3000VA**

- 2 x Positive DC cable - Red - 0.35 m
- 1 x Positive DC cable - Red - 1.0 m
- 1 x Negative DC cable - Black - 1.7m
- 1 x DC Isolator switch
- 1 x Mega-Fuse & Holder 300A (2000VA) or
- 1 x Mega-Fuse & Holder 400A (3000VA)

**ANCILLARIES - ALL MODELS**

- RCD Fused Spur - 30 mA - 40 ms - with back box - Timeguard Valiance, Type A, RCD10WPVN
- AC Isolator switch
- 2 x Battery terminal safety caps

**NOTES**

- The DC Cables are not connected to the unit but are instead supplied loose within the packaging as described above
- Cables supplied with 500VA – 800VA inverters are fitted with pin terminals at the inverter end of the cable and stud-connectors at the battery and isolator ends of the cable.
- Cables supplied with 2000VA – 3000VA inverters are fitted with stud-connectors at both ends for connection between inverter, wall mounted DC ON/OFF (Isolator) switch, MEGA-FUSES and battery.
- The T-Sense cable is not connected and is supplied loose in the packaging
- The AC-IN and AC-OUT connectors are pre-fitted to the 500VA-800VA Inverter/Charger models and will need to be pulled/removed to be then connected to the cables

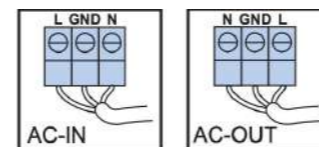

**WARNING: ELECTRIC SHOCK HAZARD**

The product is used in conjunction with a permanent energy source (battery). Input and/or output terminals may still be dangerously energised, even when the equipment is switched off. Always switch off the AC supply and the battery isolator switch before carrying out maintenance or servicing the product.

Read the installation instructions in the installation manual before installing the equipment.

This is a Safety Class I product (supplied with a protective grounding terminal).

Uninterrupted protective grounding must be provided at the AC input and/or output terminals. Alternatively, the grounding point located externally on the product may be used. Whenever it is likely that the grounding protection has been damaged, the product must be turned off and secured against unintended operation; please contact qualified service staff.

Ensure that the AC input cables are fused or fitted with circuit breakers. The DC input is fused at the inverter on the 500VA-800VA models and is fused via a Mega-Fuse on the 2000VA-3000VA models. The product must be installed in a dry and well-ventilated area. There should be a clear space of at least 100mm around the appliance for cooling.

Excessively high ambient temperature will result in the following:

- Reduced service life
- Reduced charging current
- Reduced peak capacity, or shutdown of the inverter
- Decreased battery life

The unit can be installed in any orientation/position except fully inverted. Never mount the appliance directly above the batteries.

**QUALIFICATIONS**

The Inverter/Charger units are mains powered and should be installed by persons who are electrically skilled by way of appropriate training or a Registered Competent Person as defined within Part P of Building Regulations to either fit a fused plug or wire directly to a fused spur. Knowledge of DC input by battery and the connection of DC battery leads to both the battery/batteries and the Inverter/Charger is required.

**NOTE:** The Victron Installation Manual states that *“This product should be installed by a qualified electrician”*.

**INSTALLATION**

**LOCATION**

The product must be installed in a dry and well-ventilated area, as close as possible to the batteries. There should be a clear space of at least 100mm around the appliance for cooling.

**GRID MAINS SUPPLY**

The inverter/charger should be supplied via a BS 60898 16A MCB, with RCD protection added to AC out from the inverter/charger to the pump.

In twin pump systems with two independent feeds then the supply which runs directly to a pump should have RCD protection incorporated..

**ENVIRONMENT**

This product should be installed in a heat-resistant, dry, habitable environment.

Prevent the presence of chemicals, synthetic components, curtains or other textiles, etc., in the immediate vicinity.

**WARNING:** Do not install within damp or dank indoor or outdoor environments as dampness and even insects can cause electrical shorting of main board and components which is not covered by the product warranty. Do not install the batteries directly below the inverter.

**CONNECTION OF THE AC CABLING**

**WARNING:** Ensure that the Inverter/Charger is switched to the OFF position via the ON/OFF switch at the bottom on the unit before connecting cables

**WARNING**

**This is a Safety Class I product (supplied with a protective grounding terminal). Uninterrupted protective grounding must be provided at the AC input and/or output terminals and/or chassis grounding point located externally on the product.**

The Inverter/Charger is provided with a ground relay that automatically connects the Neutral output to the chassis if no external AC supply is available. If an external AC supply is provided, the ground relay will open before the input safety relay closes. This ensures the correct operation of an earth leakage circuit breaker that is connected to the output. An uninterrupted grounding can also be secured by means of the grounding wire of the AC input. Otherwise the casing must be grounded.

**NOTE: PROTECTION OF AC-OUT WHEN CONNECTED TO CONTROL PANEL**

When the control panel and pumping system are operating normally using mains 230 VAC power, the electrical circuit is protected by the RCBO on the consumer-board, which will trip if there is an electrical fault/defect on the control panel or pump.

During mains power outage, the control panel and pumping system are connected to an independent power source in the form of the Victron Inverter/Charge which does not have protection built-in to the unit. Protection of the 230 VAC connection between the Inverter/Charger and the connected electrical device should be provided by fitting the included 30mA RCD Fused Spur by Timeguard. <https://www.timeguard.com/products/safety/rcd-protection-sockets/valiance-rcd-protected-single-gang-white-fused-connection-unit-passive>

The included AC isolator switch should also be fitted in-line between inverter/charger and AC device (panel or pump).

**INTERNAL DC FUSES**

The Inverter/Charger units include DC fuses. The 2000-3000VA Inverter/Charger units are supplied with external fuses. If replacement fuses need to be fitted, this should be carried out by a qualified and competent person.

	12/500/20	12/800/35	12/2000/120	12/3000/120
Automotive Bolt-Down Fuse MIDI or BF1 32 V	125 A	150 A		
Victron Energy MEGA-Fuse 32V			300 A	400A

FIG A - 500VA & 800VA

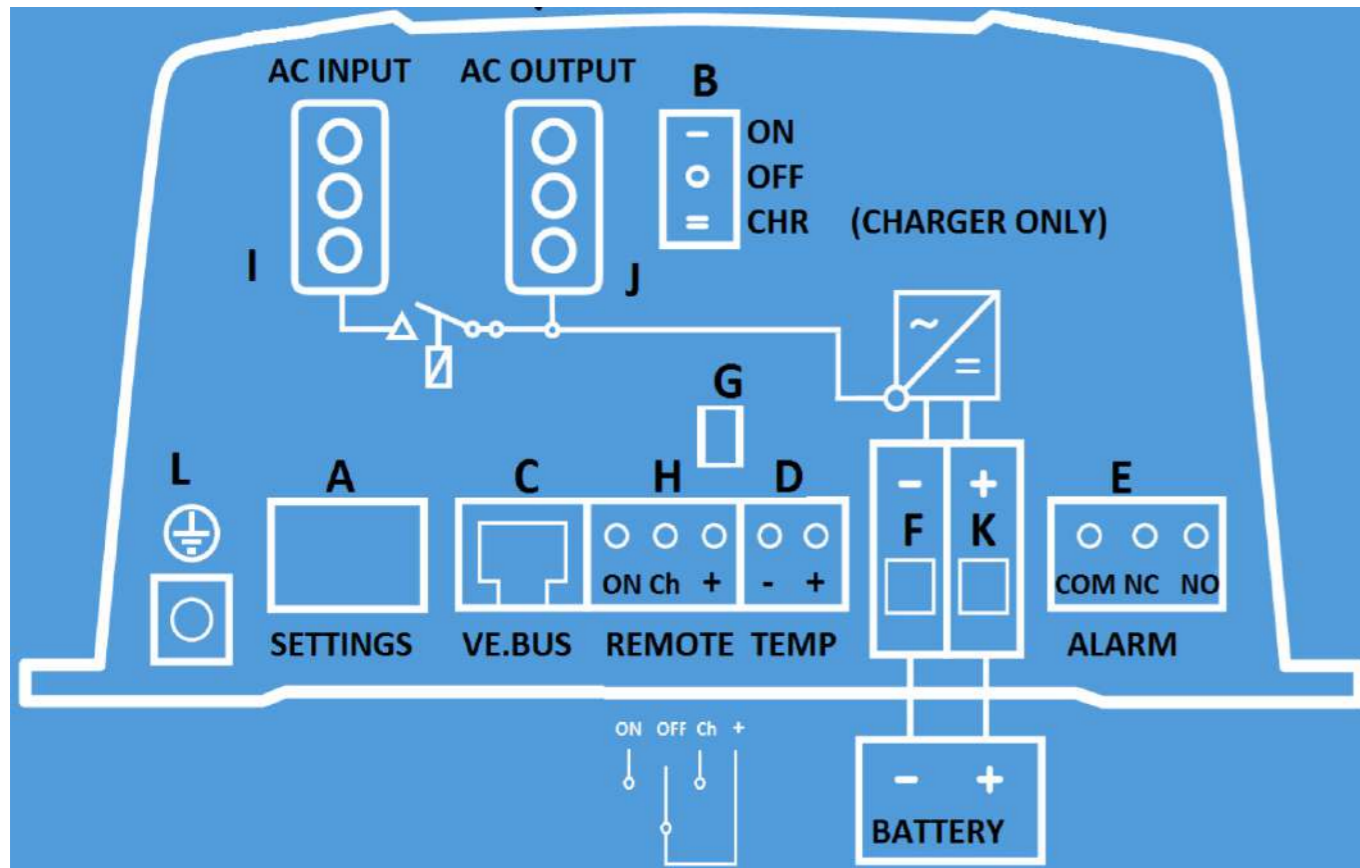
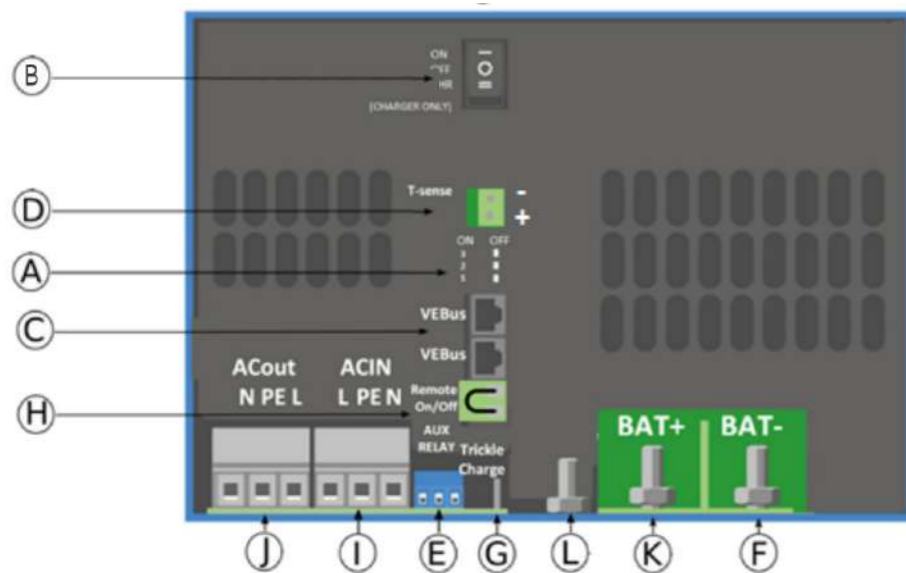

FIG B - 2000VA



	EN
A	DIP switch Remove cover
B	On/off/charger only switch
C	VE.BUS Communications port
D	Temperature sensor
E	Alarm contact
F	Batterie Minus
G	Starter battery plus
H	Remote control
I	Mains IN
J	Mains/converter OUT
K	Battery plus
L	Earth connection

**AC POWER OUT TO PUMP OR CONTROL PANEL**

1. Remove the right (AC OUTPUT) wiring block from the base of the inverter (item J)
2. Wire AC OUTPUT with correctly rated mains cable to the AC isolator switch and to the RCD fused spur.
3. Connect the Newton automatic pump, or control panel to the RCD fused spur
4. Plug in the AC OUTPUT wiring block back into the AC OUT socket of the Inverter

**MAINS CABLE CONNECTION - AC POWER IN**

1. Remove the left (AC INPUT) wiring block from the base of the inverter (item I)
2. Wire AC IN with correctly rated mains cable
3. Wire to a switched fused spur, or fused plug, both of which should be fitted with a 13 amp fuse. Do not plug in or turn on at the spur at this stage
4. Plug in the AC IN wiring block back into the AC IN socket

**CONNECTION OF THE DC CABLING**

**WARNING:** Ensure that the Inverter/Charger is switched to the OFF position via the ON/OFF switch at the bottom on the unit before connecting cables

Before connections are made, test the batteries open circuit voltage. This should be at a minimum of 12.7 VDC before installation.

DC cables are included as confirmed on page 3. If longer cables are required, please ensure the following specifications are used:

	12/500/20	12/800/35	12/2000/80	12/3000/120
Recommended cross section (mm <sup>2</sup> ) 1.5 to 5m length	16	25	70	95

**CONNECTION OF BATTERY CABLES TO INVERTER**

The DC cables have crimped pin-terminals pre-fitted for the Inverter/charger side connections into terminals F & K.

Insert the red (positive) cable into terminal K and the black (negative) cable into terminal F. Tighten using the Phillips screw at the front of each terminal.

The DC cables for 2000-3000VA models have stud eyelets pre-fitted for the inverter/charger side connections into terminals F & K.

**CONNECTION OF CABLES TO BATTERY**

- Use PZ 2 screwdriver for MultiPlus 500/800 VA
- Use M8 Spanner for MultiPlus 2000/3000 VA

Use insulated tools in order to avoid shorting the battery. Avoid shorting the battery cables

**WARNING:** Reverse polarity connection (+ to - and - to +) will cause damage to the product and will void the warranty

The terminal nuts should be tightened to torque figure 8.0 Nm/71 in-lb

1. Connect black battery cable and **temperature sensor cable** to the negative battery terminal
2. Connect the red battery cable to the isolation switch and/or mega-fuse, then the positive battery terminal
3. Fit Battery Terminal covers

**TEMPERATURE SENSOR**

Insert the Temperature Sensor cable into terminal D of the Inverter/Charger. **WARNING: If the Temperature Sensor Cable is not correctly fitted, the charger will not charge the batteries.**

**OPERATION**

The Inverter/Charger is now ready to use.

Switch the unit on at the plug or switched spur. Switch on the Inverter/Charger via the ON/OFF switch at the bottom on the unit. The green 'Inverter' light will be illuminated.

If the Mains AC voltage connected to the 'AC in' terminal is within specifications, Mains AC will be switched through to the 'AC out' terminal, providing mains power to the pump or control panel and the inverter will switch off, the green 'Inverter' light will no longer be illuminated and instead the yellow 'Charger' LED will light up and the charger commences charging the batteries.

If the AC-in voltage is not within specifications, the unit will enter Power Assist Mode, the inverter will remain switched on with solid green and flashing yellow lights illuminated.

**WARNING:** If this condition continues, investigation of the mains supply by a qualified electrician is required.

**LED INDICATIONS - Switch position - ON**

**LED INDICATIONS - Switch position - CHARGER ONLY**

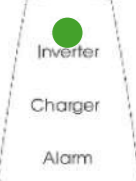
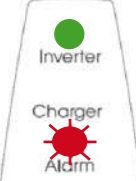
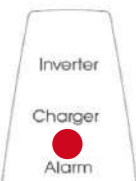
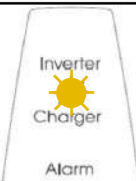
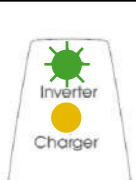
<p>1. </p>	<p><b>On / Off / Charger-only switch = On</b> The inverter is switched on and supplies power to the load.</p>
<p>2. </p>	<p><b>On / Off / Charger-only switch = On</b> The inverter is switched on and supplies power to the load. Pre-alarm: overload, or battery voltage low, or inverter temperature high.</p>
<p>3. </p>	<p><b>On / Off / Charger-only switch = On</b> The inverter is switched off due to one of the following alarms: overload, or battery voltage low, or inverter temperature high, or DC ripple voltage too high.</p>
<p>4. </p>	<p><b>On / Off / Charger-only switch = On</b> The AC input voltage is switched through and the charger operates in float mode.</p>
<p>5. </p>	<p><b>On / Off / Charger-only switch = On.</b> <b>PowerControl and PowerAssist:</b> The AC input is switched through and the charge current is zero. The inverter is switched on and, in case of PowerAssist, assists the AC input by supplying additional power to the load (see section 2.1).</p>

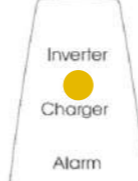
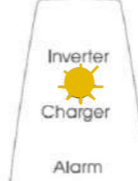
<p>6. </p>	<p><b>On / Off / Charger-only switch = Charger only</b> The AC input voltage is switched through and the charger operates in bulk or absorption mode.</p>
<p>7. </p>	<p><b>On / Off / Charger-only switch = Charger only</b> The AC input is switched through and the charger operates in float or storage mode.</p>

- No mains 230 VAC - Pumps powered by 12 VDC power inverted to 230 VAC**  
At initial start and also when mains 230 VAC power has failed and the pumps/panel are powered by the inverter using 12 VDC from the battery.  
**This condition is only normal during a mains power outage.**
- PRE-ALARM CONDITION - No 230 VAC - Pumps powered by 12 VDC power**
  - Overload - The load on the inverter is higher than the nominal load
  - Battery voltage low - The DC input voltage is low - battery is depleted
  - Inverter temperature high - The ambient temperature is too high

**CONSULT TROUBLESHOOTING TABLE ON PAGES 11 & 12**
- ALARM CONDITION - FULL INVERTER & CHARGER SHUTDOWN**
  - Overload - The load on the inverter is higher than the nominal load
  - Battery voltage low - The DC input voltage is low - battery is depleted
  - Inverter temperature high - The ambient temperature is too high

**CONSULT TROUBLESHOOTING TABLE ON PAGES 11 & 12**
- Normal operating state where mains 230 VAC is connected and the battery is fully charged.
- Poor quality mains 230 VAC. Inverter is supplementing or 'cleaning' the poor quality mains 230 VAC.  
**WARNING:** If this condition continues, investigation of the mains supply by a qualified electrician is required.
- Normal operating state where mains 230 VAC is connected and the battery is not fully charged. After a period of time, dependent on the battery size, the yellow light will begin to flash with and the charger will return to condition 5.
- Normal operating state where mains 230 VAC is connected and the battery is fully charged.

**CONFIGURATION**

- Settings should be carried out by a competent person
- Carefully read the instructions before changes are made
- Batteries should be in a dry and well-ventilated area during charging

**Standard settings: ready for use**

On delivery, the unit has been programmed by Newton ready for use as part of a Newton Pumping System with charging voltages matched to the battery bank size also supplied by Newton Waterproofing Systems. There is no need to change any of the settings.

Trained engineers can reprogram the unit if needed.

If battery bank size is changed, the unit should be re-programmed by a trained engineer.

**MAINTENANCE**

The unit does not require specific maintenance. All connections should be checked once a year as part of the pump servicing regime. Avoid moisture, oil/soot/vapours, and keep the device clean.

**WARRANTY STATEMENT**

The Victron Inverter/Chargers are covered by a 5 year warranty. Warranty includes next-day on-site replacement (delivery and collection, not decommission and installation) of the Inverter/Charger units by a replacement of the same model.

Limited Product Warranties. 5-year limited product warranty from date on delivery note or invoice to the customer.

**WHAT IS COVERED BY THIS LIMITED HARDWARE WARRANTY?**

This limited warranty covers replacement only for defects in materials and workmanship.

**WHAT IS NOT COVERED BY THIS LIMITED HARDWARE WARRANTY?**

- Products the supplier has not received payment for
- Normal wear and tear
- Failure to follow product installation instructions and user instructions
- Usage that is not in accordance with the product instructions
- Servicing not authorised by the manufacturer
- Problems caused by connecting devices not supplied or authorised by the manufacturer

**WARRANTY INFORMATION**

This warranty gives you specific legal rights, and you may also have other rights which may vary from area to area (or jurisdiction to jurisdiction). The manufacturer's responsibility for malfunctions and defects in the product is limited to repair and replacement as set forth in this warranty statement. All expressed and implied warranties for the product (including but not limited to any implied warranties and conditions of merchantability and fitness for a particular purpose), are limited in time to the term of the limited warranty which is the 5-year period reflected on your delivery note or invoice. No warranties, whether expressed or implied, will apply after the limited warranty period has expired.

We do not accept liability beyond the remedies provided for in this limited product warranty or for consequential or incidental damages, including without limitation, any liability for third-party claims against you, for damages for products not being available for use. Our liability will be no more than the amount you paid for the product that is the subject of a claim. This is the maximum amount for which we are responsible. Newton Waterproofing Systems reserve the right to change the product specification at any time.

**TROUBLESHOOTING**

The following table provides a quick reference of the more common faults. Disconnect the battery/batteries and pumping systems before diagnosing the fault. Consult Newton Waterproofing Systems if the fault cannot be resolved.

Problem	Cause	Solution
The charger is not functioning	The AC input voltage or frequency is out of range	Ensure that the input voltage is between 185 VAC and 265 VAC, and that the frequency matches the setting.
The battery is not being charged fully	Incorrect charging current	Set the charging current at between 0.1 and 0.2x battery capacity.
	A defective battery connection	Check the battery terminals.
	The absorption voltage has been set to an incorrect value	Adjust the absorption voltage to the correct value.
	The float voltage has been set to an incorrect value	Adjust the float voltage to the correct value.
The battery is overcharged	The internal DC fuse is defective	Inverter is damaged.
	The absorption voltage has been set to an incorrect value	Adjust the absorption voltage to the correct value.
	The float voltage has been set to an incorrect value	Adjust the float voltage to the correct value.
	A defective battery	Replace the battery.
	The battery is too small	Reduce the charging current or use a battery with a higher capacity.
Battery charge current drops to 0 when the absorption voltage is reached	The battery is too hot	Connect a temperature sensor.
	Alt. 1: Battery overtemperature (> 50 °C)	- Allow battery to cool down - Place battery in a cool environment - Check for shorted cells
The inverter fails to operate when switched on	Alt 2: Battery temperature sensor faulty	Unplug battery temperature sensor from the Multi. Reset the Multi by switching it off, then wait for 4 seconds and switch it on again. If the Multi now charges normally, the battery temperature sensor is faulty and needs to be replaced.
	The battery voltage is too high or too low	Ensure that the battery voltage is within the correct value.
The inverter fails to operate	Processor in no function-mode	Disconnect mains voltage. Switch front switch off, wait 4 seconds. Switch front switch on.

# Victron MultiPlus

Inverter/Charger Battery Back-Up - 500VA to 3000VA

## TROUBLESHOOTING CONTINUED

The alarm LED flashes	Pre-alarm alt. 1. The DC input voltage is low	Charge the battery or check the battery connections.
The alarm LED flashes	Pre-alarm alt. 2. The ambient temperature is too high	Place the inverter in a cool and well-ventilated room, or reduce the load.
The alarm LED flashes	Pre-alarm alt. 3. The load on the inverter is higher than the nominal load	Reduce the load.
The alarm LED flashes	Pre-alarm alt. 4. Voltage ripple on the DC input exceeds 1.25Vrms	Check the battery cables and terminals. Check the battery capacity; increase if necessary.
The alarm LED flashes intermittently	Pre-alarm alt. 5. Low battery voltage and excessive load	Charge the batteries, reduce the load or install batteries with a higher capacity. Use shorter and/or thicker battery cables.
The alarm LED is on	The inverter did cut out following a pre-alarm	Check the table for the appropriate course of action.

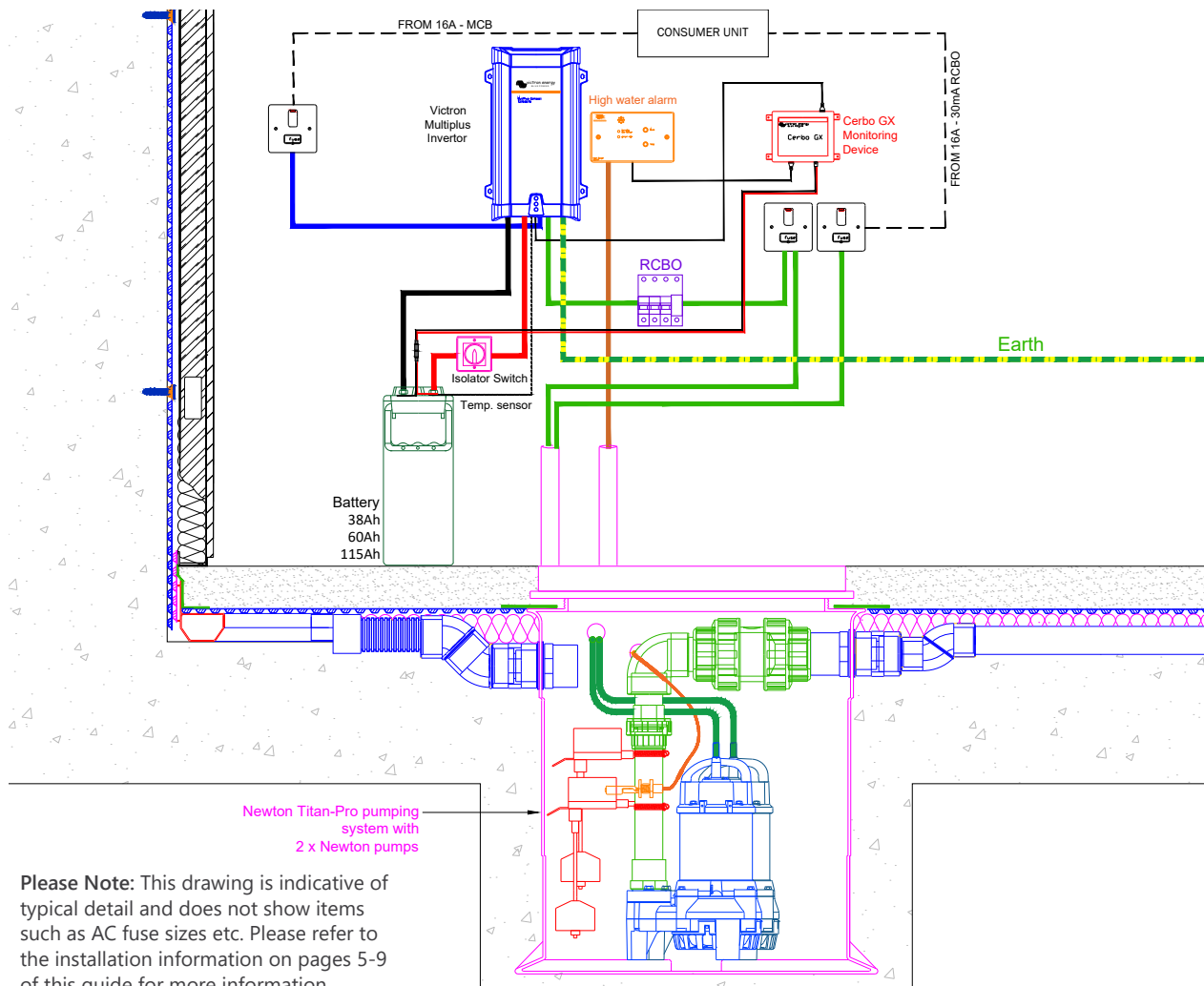

**Please Note:** This drawing is indicative of typical detail and does not show items such as AC fuse sizes etc. Please refer to the installation information on pages 5-9 of this guide for more information.

Newton Waterproofing Systems reserve the right to update product literature at any time. Please always refer to our [website](http://www.newtonwaterproofing.co.uk) for the latest versions.